



# ETA-USA

The Power Professionals

## ZMP400

## 400W AC/DC



### Features

- ITE & Medical Dual Safety Approvals
- High Power density, 400W in 5" x 3.2" footprint
- Medical safety approved (2 x MOPP between primary to secondary and meet BF type.)  
Isolation Voltage 5,656 VDC
- ITE up to 5000m, Medical Below 3000m
- No load power consumption <0.5Watts. (for 5Vsb standby mode)
- Main output and Standby output Power ON LED indicators
- 3 years warranty
- Single output, 12V, T-Type (Top mounted fan), 400W Convection.

RoHS CB    CE   FC

MODEL/CHANNEL		Unit	ZMP400-12	ZMP400-24	ZMP400-28	ZMP400-48	ZMP400-54
OUTPUT	Nominal Voltage	V	12	24	28	48	54
	Current	A	33.33	16.66	14.28	8.33	7.4
	Ripple and Noise	mVp-p	240	300			
	Efficiency Typ.	%	> 91% typical @full load, 230VAC				
	Fan Output	V	5V/0.3A				
	Standout Supply	V	12V/0.25A				
	Total Power	W	400Watts with forced air cooling,				
	Operating Frequency	KHZ	47-63Hz				
	Output Regulations	%	±3%				
MODEL/CHANNEL		Unit					
INPUT	Nominal Voltage	V	90-264VAC				
	Inrush Current	-	< 45A peak @ 115VAC; < 80A peak @ 230VAC cold start @ 25°C				
	Input Current	-	4.2A @ 115VAC; 2.1A @ 340VAC max.				
	Remote On/Off	-	Remote control (Inhibit) function				
	Power Factor	-	> 0.95 @ 115VAC; > 0.9 @ 230VAC @ full load				
	Hold up time	-	> 10ms typical 50% load, 115VAC				



# ETA-USA

16170 Vineyard Blvd. Suite 180 Morgan Hill, CA 95037 <http://www.eta-usa.com>

Toll-free (US only): 800-ETA-POWER (800-382-7697) Telephone: 408 778-2793 FAX: 408-779-2753

©2014 ETA-USA All Rights Reserved

ETA-USA reserves the right to make changes to the products and specifications without prior notice. Please contact the factory for latest information.



## ZMP400

	MODEL/CHANNEL	Unit	
<b>Function</b>	Short Circuit	-	Auto-recovery
	Overload Protection	A	110% to 160% maximum rating, Auto-recovery
	Over voltage Protection	-	Auto-recovery
	Cooling / O.T.P	-	Derate linearly 2.5% per°C from 51 to 70°C; Derate linearly 1% per°C from -1 to -20°C
<b>Environment</b>	Operating temp. & Hum.	-	-20 to +70°C (Refer to "Derating Curve"); Non-condensing 0% to 90%.
	Storage temp. & Hum.	-	-20°C to +85°C; Non-condensing 0% to 90%.
	MTBF	-	> 250,000 hours @full load and 25°C ambient temperature per telcordia(Bellcore TR-332)
<b>Dimension</b>	Size(WxLxH) / Weight	mm/g	81x127x68/657
	<b>Safety</b>	-	UL/c-UL 60601-1 3.1 Edition    CB IEC60601-1 3.1 Edition    CB IEC 62368-1 UL/c-UL UL62368-1    TUV EN62368-1    TUV EN60601-1 3.1 Edition
	<b>Emission</b>	-	EN60601-1-2 Ed4:2015    IEC60601-1-2 Ed4:2014    EN 55011 Class B    CE EN55032 Class B    EN55024 Class B    FCC Part 15 Class B    FCC Part 18 Class B

## Output Derating Curve

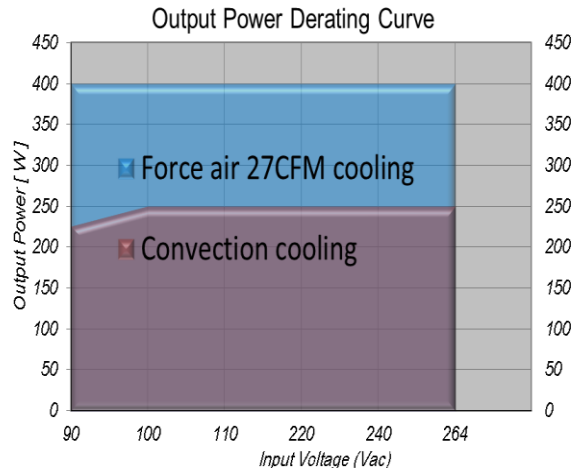
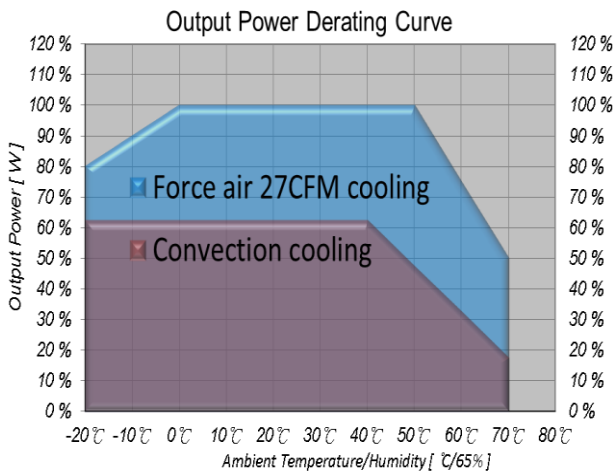



# ETA-USA

The Power Professionals

## Pin Output

### T-Type (U Channel with top mounted fan)

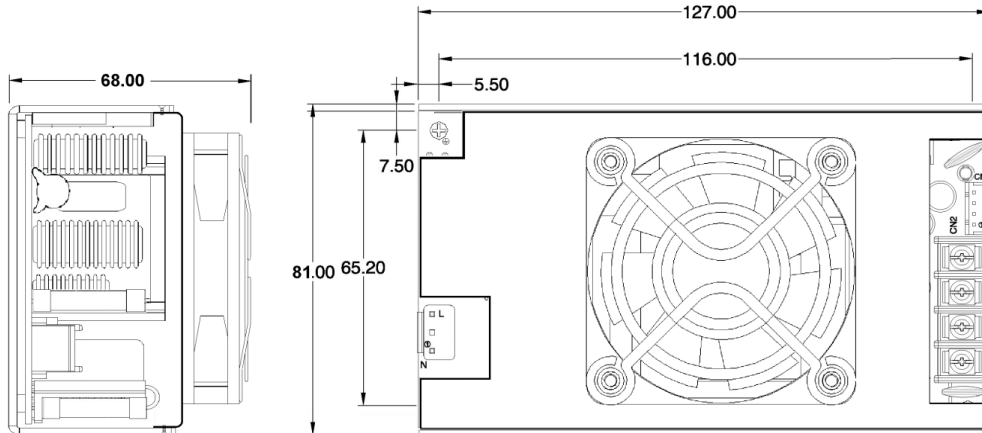

**Dimension:** L127xW81xH68mm

**Tolerance:** L +/-1.5mm

**W&H:** +/-0.5mm

#### Mounting notes

L : max penetration depth

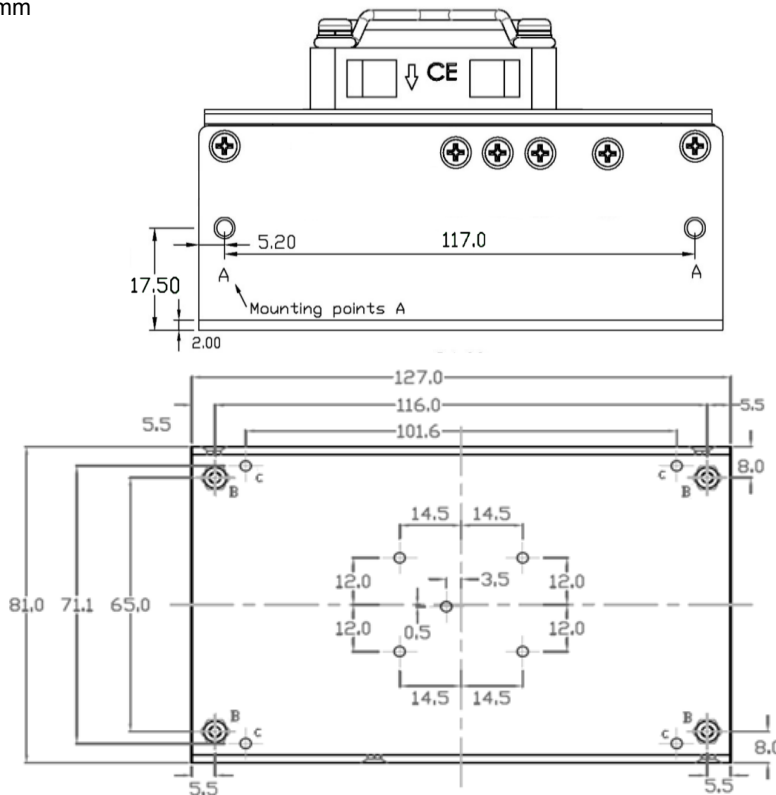
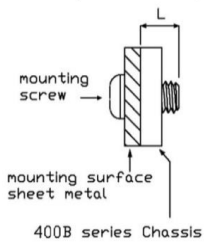

#### Note:

U Chassis connected to earth ground, for optimum SAFETY and EMI performance.

Mounting points A, M3x0.5 thread, max penetration depth 5mm.

Mounting points B, M3x0.5 thread, max penetration depth 2.5mm.

Mounting points C, M3x0.5 thread, max penetration depth 0.5mm.



# ETA-USA

16170 Vineyard Blvd. Suite 180 Morgan Hill, CA 95037 <http://www.eta-usa.com>

Toll-free (US only): 800-ETA-POWR (800-382-7697) Telephone: 408 778-2793 FAX: 408-779-2753

©2014 ETA-USA All Rights Reserved

ETA-USA reserves the right to make changes to the products and specifications without prior notice. Please contact the factory for latest information.



## Mechanical Specifications

### Pin assignment

#### CN1: Input Connector

JST B2P3-VH pitch: 3.96mm or equivalent, mates with JST VAR-2 or equivalent

Pin #	Signal
1	AC Neutral
2	AC Line

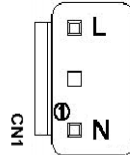

#### CN2: Main Output Connector

##### Terminal Block Type

4-Pole Terminal block pitch: 8.25mm, rate 20A/300V or equivalent

Pin #	Signal
1	GND
2	GND
3	+Vout
4	+Vout

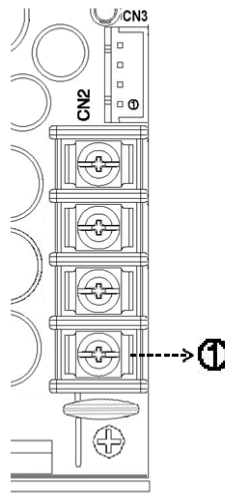

#### CN3: Remote control & Standby supply

JST B4B-XH-A pitch: 2.5mm or equivalent, mates with JST XHP-4 or equivalent

Pin #	Signal
1	GND
2	+5VSB
3	INHIBIT (Remote control)
4	GND



INHIBIT→ Logic level HIGH (5V) or Floating : Enable, Logic level LOW : Disable

#### CN4: FAN Output Connector

JST B2B-XH-A pitch: 2.5mm or equivalent, mates with JST XHP-2 or equivalent

Pin #	Signal
1	+12V FAN+
2	GND FAN-

